



# Aluminium Bi-fold and Sliding Door Systems

[aluk.co.uk](http://aluk.co.uk)

Experts in Aluminium

**ALUK**<sup>®</sup>



# Contents

5 By Experts

6 Why Choose Aluminium?

8 A System for Every Application

10 Tested, Tried and Trusted

13 Door Systems

14 Infinium Sliding

16 Luminia SC156 Lift & Slide

18 Optio BSC94 Lift & Slide

20 Optio BSC94 In-Line Sliding

22 Luminia F82 Bi-Fold

24 Optio BSF70 Bi-Fold

26 Hardware



---

AT ALUK WE BELIEVE  
COLLABORATION IS KING.  
IT'S WHY WE'RE PROUD OF  
THE PARTNERSHIPS WE'VE  
BUILT WITH FABRICATORS,  
INSTALLERS AND  
ARCHITECTS THROUGHOUT  
THE UK AND BEYOND

---

## By experts, for experts

It's fair to say we live and breathe aluminium at AluK. From its melting point of 660.32°C to its remarkable low density and vital role in the aerospace industry, there's little we don't know about atomic number 13. More importantly, we're experts at using this versatile metal to create high-performing and sustainable door systems that surpass the needs of fabricators and installers across the UK.

From the production line to our design and sales offices, every member of the AluK team is a leader in their field. It's this collective expertise alongside our traditional family values that have enabled us to design, engineer and manufacture industry-leading façade systems for over 25 years.

Boasting slimmer sightlines and greater feature options, all our products are manufactured to the highest UK standards. So whether commercial or residential, modern or traditional, you can be confident our experts will ensure every AluK product delivers peerless performance and signature style.

*Russell*  
**Russell Yates**  
AluK Managing Director

# Why choose AluK aluminium systems?

For over 25 years, we've been at the forefront of aluminium door design.

## But why aluminium?

It's lightweight, strong and almost 100% recyclable.

It doesn't warp or rust and is near maintenance-free.

Plus it's exceptionally versatile and easy to install.

And that's really just for starters.

## Design

Without compromising on strength, our aluminium door systems are designed to offer your customers the narrowest of sightlines, allowing bigger glazing and providing greater light into their homes.

Our integrated systems are designed for maximising profiles and parts, as well as to ensure fast fabrication and a wide range of installation options.

## Colour

Access a large spectrum of contemporary and classic colour choices and finishes.

We also offer a range of standard single and dual colour products from stock with our Colour+ offer.

For full Colour+ details email [info@aluk.co.uk](mailto:info@aluk.co.uk)

## Security

We understand the importance of security to your customers. That's why all our door systems are independently tested to ensure they not only meet current security regulations for new builds, but that they're inherently burglar resistant too.

Most of our systems are also certified by PAS 24, Secured By Design and Q-marked accredited.

## Thermal efficiency

Our door systems offer award-winning U-value performance for both double and triple glazing.

In fact, we were the first company to ever gain an A-rated aluminium double glazed system in the market.

## Performance

Each system includes water and acoustic barriers, and utilises the latest manufacturing technologies and techniques to provide long-term peace of mind.

They also have integrated drainage paths that allow water to pass through the system.

This, combined with the high quality air seals and barriers, ensures they can tackle the everchanging British climate with ease.

## Energy Ratings (WERs)

Our aluminium door systems are rated for their energy efficiency using the familiar A-G scale. This means homeowners and architects can instantly see which doors to choose.

WERs also affect fabricators, because in order to supply WER

products a fabricator must join an official and recognised scheme.

This is to ensure that manufacturers can prove they have audited processes in place and that the ratings displayed are accurate. As you'd expect, we have our own group scheme at AluK.

This provides members fast-track access to all our WER data, saving them valuable time and effort.

For a more detailed look at the ratings, download our **WER guide** at [aluk.co.uk](http://aluk.co.uk)

## Service excellence

Expert service is key at AluK, so our trained architectural technicians and engineers are always on-hand to offer guidance and support from design through to installation.

We also have highly experienced Project Consultants able to help with design, system selection, construction details and project specifications for your specific sector.

## AluK Academy

Training is another key service we provide. From CPDs and toolbox talks to hands-on guidance at our Academy Centre, we provide a wide range of training options to all our customers.

To find out more simply email [training.uk@aluk.com](mailto:training.uk@aluk.com)

# An AluK system for every application

If there's one thing homeowners, architects, installers and fabricators all have in common, it's their desire for choice. That's why we've created our wide range of aluminium façade systems to meet the needs of different application, performance and aesthetic demands.

To make life easy for homeowners, we've created three product ranges based on their individual requirements:

- ▶ For those looking for the thinnest sightlines and finest finish, there's our premium Infinium sliding door.
- ▶ If outstanding quality and stand-out at a competitive price is desired, the Luminia range is the obvious choice.
- ▶ For stylish design and everyday practicality, opt for the Optio range of door systems.

From a fabricator and installer perspective, we offer systems that cover everything from new builds, replacements and large-scale refurbishment projects.

Whatever choice you make, you can be confident that our systems offer the superior performance and quality of aluminium through and through.



New builds

Residential replacement

# Tested, tried and trusted

From trusted favourites to the latest innovations, our comprehensive range of aluminium door systems has been designed and developed with fabricators, installers and homeowners in mind at every stage.

Furthermore, every system delivers the aesthetic appeal and exceptional build quality demanded by the industry.

It also goes without saying they've all been tested and certified to the latest standards and accreditations.

These include PAS 24, BS4873, Secured By Design and Qualicoat for starters. Not to mention ISO 9001. They also hold Q-Mark

Certifications for enhanced security doors. Should we go on?

Whichever system you choose, we'll work closely with you to ensure you have all the information you require for successful fabrication and installation.

All the latest structural, thermal and wind calculations are available, as is a comprehensive suite of CAD, NBS Specifications performance and environmental data.

ALWAYS UP TO THE TEST





# AluK door systems

Engineered to integrate seamlessly with our window system range, our aluminium door systems remain our most popular products and provide unrivalled safety, security and installation simplicity.

Each door system has its own distinct look and feel, offering varying levels of performance, profile depth and glazing area.

However, while our designs may differ you'll find our materials and manufacturing processes are as reliable as ever - you have our guarantee. A 10-year one, in fact.

In addition to meeting the needs of every application type, our doors also support the current industry trend for refurbishment over replacement.

This allows fabricators and installers to provide the additional light and space their customers want, in the most befitting way possible.



# INFINIUM Sliding Door

Infinium brings together indoor and outdoor living spaces in exquisite harmony.

Free-flowing spaces are created thanks to stunningly slim sightlines that bathe every surface with natural light. Uninterrupted panoramic landscapes provide complete escapism, without the need for escape.

Also, seamlessly integrated floor-to-ceiling glazing reflects the clarity of thought behind every inspired design decision.

Visit [infinium.aluk.com](http://infinium.aluk.com) for more information and to request a brochure.

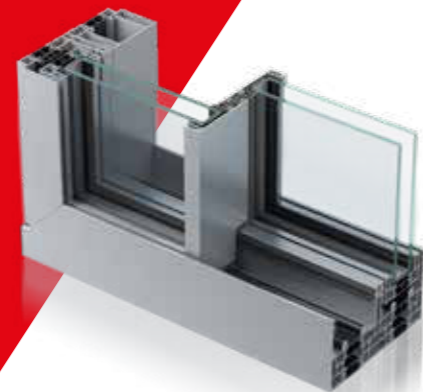

## DESIGN FEATURES

- Sliding door
- Fully concealed outer-frame
- 21mm central interlock
- One or more opening panels with large width dimensions up to 3000mm (W) and height dimensions up to 3500mm
- Holds up to 400 kg panel weight

## OPTIONS

- Available in double or triple track
- Glazing options of 38mm - 52mm
- Floating corner post option for larger opening space
- Single colour available as standard
- Available in a range of configurations
- Double or triple glazing solutions available on the same outer-frame

## SPECIFICATIONS

### Performance & accreditations

Uw-Value (Double Glazing)	1.3 W/m²K
Uw-Value (Triple Glazing)	< 1.0 W/m²K
Air Tightness	Class 4 (600 Pa)
Water Tightness	Class 8A (450 Pa)
Wind Load	Class C3 (1200 Pa, up to 160 km/h)

### Size limits

Max Sash Weight	400kg
Max Sash Dimension	3000mm (w)   3500mm (h)

### System features

Dual colour option	✓
Multi-point locking	✓
Glazing options	38mm - 52mm

## INFINIUM CONFIGURATIONS

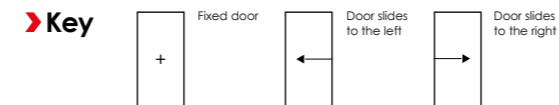

The diagrams showed here illustrate some of the configurations achievable with AluK's Infinium system.

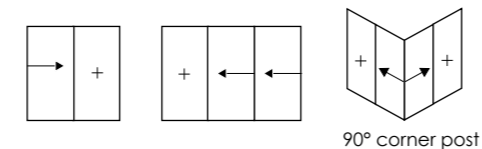
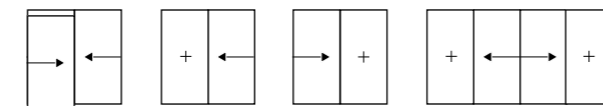

## CAD CROSS SECTIONS

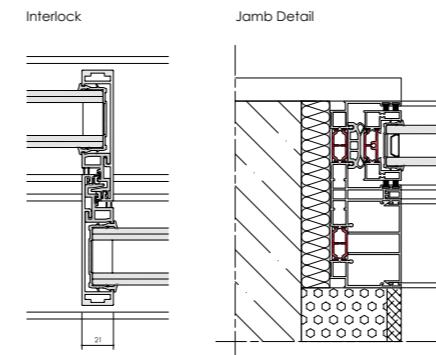

Sill Detail

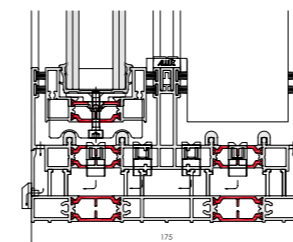



Luminia

# SC156 Lift & Slide Door

A premium sliding door system with slim sightlines available in a variety of sliding configurations, using single and double track systems.

The Luminia SC156 offers high levels of performance, from thermal U-values of 1.0W/m<sup>2</sup>K (triple glazed), to the most superior water tightness on the market (1500 Pa) and panel weights of up to 400Kg.

Smooth operation is guaranteed through the use of the highest quality fittings.



## DESIGN FEATURES

- Accepts 24mm - 50mm double or triple glazing
- Max 400kg panel weight
- Low threshold of 23mm
- Exceptional AWW ratings
- PAS 24 Accredited

## OPTIONS

- Slimmer sightline of 50mm available
- Multiple sliding configurations
- Mono or Dual rail options
- Available in single and dual colour; any other RAL also available
- Range of hardware and security features

## SPECIFICATIONS

Performance and accreditation	SC156	SC156SLIM
U-value (Double Glazing)* (Ug = 1.0 W/m <sup>2</sup> K) (Mono Rail)	1.4 W/m <sup>2</sup> K	1.4 W/m <sup>2</sup> K
U-value (Triple Glazing)* (Ug = 0.6 W/m <sup>2</sup> K) (Mono Rail)	1.0 W/m <sup>2</sup> K	1.0 W/m <sup>2</sup> K
U-value (Double Glazing)* (Ug = 1.0 W/m <sup>2</sup> K) (Dual Rail)	1.5 W/m <sup>2</sup> K	1.6 W/m <sup>2</sup> K
U-value (Triple Glazing)* (Ug = 0.6 W/m <sup>2</sup> K) (Dual Rail)	1.2 W/m <sup>2</sup> K	1.3 W/m <sup>2</sup> K
Acoustic Performance (dB)	Rw(Ct;Ctr) = 44 (-2;-6) dB	Rw(Ct;Ctr) = 44 (-2;-6) dB
Air Tightness (Pa)**	Class 4 (600 Pa)	Class 4 (600 Pa)
Water Tightness (Pa)**	Class E1500 (1500 Pa)	Class E1500 (1500 Pa)
Wind load (Pa)**	C4 (1600 Pa)	C4 (1600 Pa)
Security	PAS 24	PAS 24
Configuration & frame		
Opening	Lift & slide	Lift & slide
Mono rail (156mm)	✓	✓
Dual rail (156mm)	✓	✓
Size limits		
Max vent weight***	400kg	400kg
Max frame height****	3100mm	3100mm
System features		
Sightlines	95mm	50mm
Dual Colour Option	✓	✓
Multi-point locking	✓	✓
Glazing options	Internal	Internal
Glazing thickness	24mm - 50mm	24mm - 50mm
Threshold	23mm	23mm

## SC156 (LIFT & SLIDE) CONFIGURATIONS

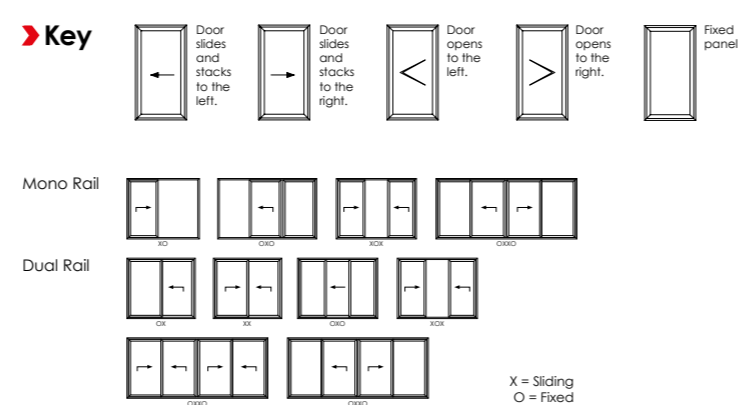

## CAD CROSS SECTIONS

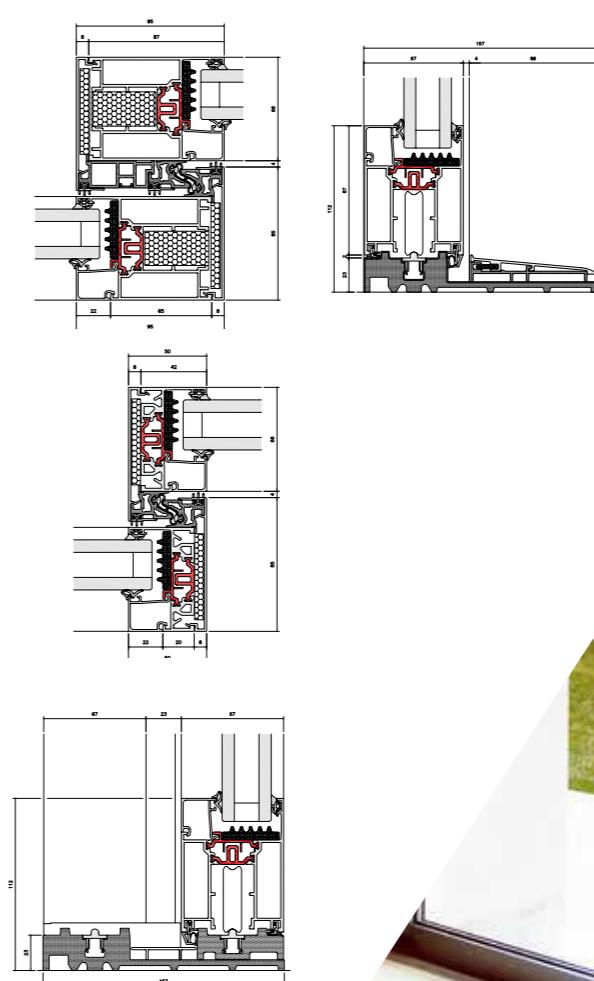

\*U-values based on CEN size door (2500mm x 2180mm).  
 \*\*All weather test data taken from BS EN 6375-1 based upon highest performing door configuration.  
 \*\*\*Based on using heavy duty accessories.  
 \*\*\*\*Dependent on wind load and lock variation.  
 Note: npd = No performance declared, image used for illustration purpose only  
 Please visit [www.aluk.co.uk](http://www.aluk.co.uk) to download all BIM components and CAD files.

Optio

# BSC94 Lift & Slide Door

For those looking for effortless operation, look no further than our premium lift and slide door. Its vital statistics are impossible to ignore.

Thermal U-Values of 1.5W/m2K (triple glazed). Panel weights of up to 400Kg. Sightlines as little as 45mm.

The list goes on. As do the benefits, including multiple configurations and a wide choice of colour finishes.



## DESIGN FEATURES

- › Accepts 20mm - 31mm double glazing
- › Max 400kg panel weight (double bogey)

## OPTIONS

- › Available as Inline Sliding
- › Slimmer sightline of 45mm available
- › Multiple sliding configurations
- › Mono or Dual rail options
- › Available in single and dual colour  
Anodised finishes also available
- › Range of hardware and security features

## SPECIFICATIONS

Performance and accreditation	BSC94
U-value (double glazing)* (Ug = 1.0 W/m²K) (mono rail)	1.6 W/m²K
U-value (triple glazing)* (Ug = 0.7 W/m²K) (mono rail)	1.4 W/m²K
U-value (double glazing)* (Ug = 1.0 W/m²K) (dual Rail)	1.7 W/m²K
U-value (triple glazing)* (Ug = 0.7 W/m²K) (dual Rail)	1.5 W/m²K
Green guide rating	C rated
Acoustic performance (dB)	npd
Air tightness (Pa)***	Class 4 (600 Pa)
Water tightness (Pa)***	Class 7a (300 Pa)
Wind load (Pa)***	C3 (1200 Pa)
Configuration & frame	
Opening	Lift & slide
Mono rail (105mm)	✓
Dual rail (94mm)	✓
Size limits	
Max vent weight***	400kg
Max frame height****	3000mm
System features	
Dual colour option	✓
Multi-point locking	✓
Glazing options	Internal
Glazing thickness	20mm - 31mm
Sightlines	100mm

Performance and accreditation	BSC94SLIM
U-value (double glazing)* (Ug = 1.0 W/m²K) (mono rail)	x
U-value (triple glazing)* (Ug = 0.7 W/m²K) (mono rail)	x
U-value (double glazing)* (Ug = 1.0 W/m²K) (dual Rail)	1.7 W/m²K
U-value (triple glazing)* (Ug = 0.7 W/m²K) (dual Rail)	1.5 W/m²K
Green guide rating	C rated
Acoustic performance (dB)	npd
Air tightness (Pa)***	Class 4 (600 Pa)
Water tightness (Pa)***	Class 7a (300 Pa)
Wind load (Pa)***	C3 (1200 Pa)
Configuration & frame	
Opening	Lift & slide
Mono rail (105mm)	x
Dual rail (94mm)	✓
Size limits	
Max vent weight***	400kg
Max frame height****	3000mm
System features	
Dual colour option	✓
Multi-point locking	✓
Glazing options	Internal
Glazing thickness	20mm - 31mm
Sightlines	45mm

## CAD CROSS SECTIONS

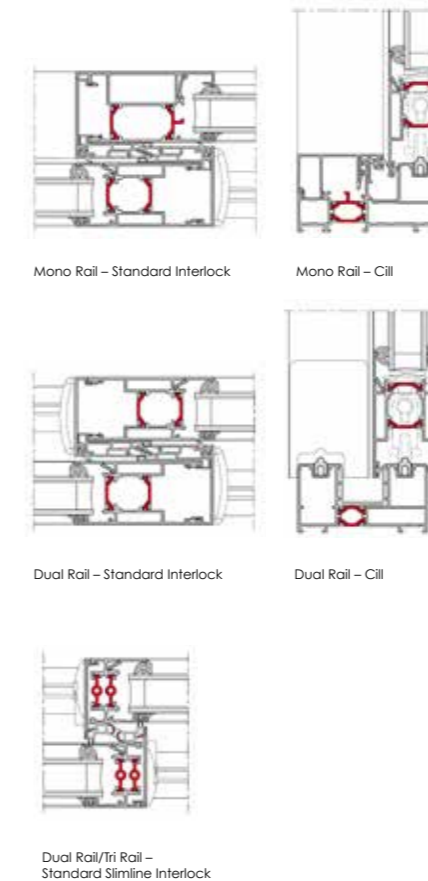

## BSC94 (LIFT & SLIDE) CONFIGURATIONS

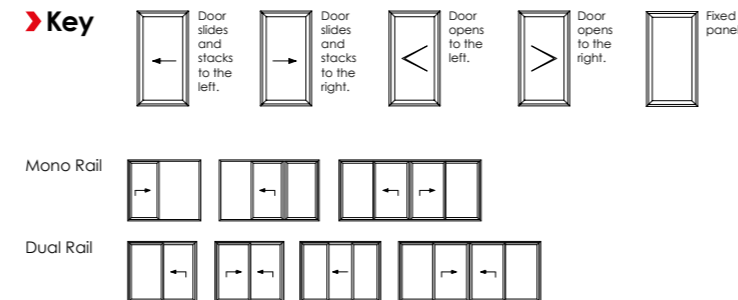

\*U-values based on CEN size door (2000mm x 2180mm).  
 \*\*All weather test data taken from BS EN 6375-1 based upon highest performing door configuration.  
 \*\*\*Based on using a Tandem bogie kit.  
 \*\*\*\*Dependent on wind load and lock variation.  
 Note: npd = No performance declared  
 Please visit [www.aluk.co.uk](http://www.aluk.co.uk) to download all BIM components and CAD files.



Optio

# BSC94 In-line Sliding Door

Combining high performance with stunning design, our sliding aluminium door systems provide a versatile solution for any architectural project.

Manufactured to the highest UK standards, this multi-configuration inline system offers outstanding thermal performance and a wide range of customisable options.



## DESIGN FEATURES

- Accepts 20mm - 31mm double glazing
- Max 400kg panel weight
- Certified PAS 24
- Anti bi-metal polyamide strip to allow for varying expansion rates

## OPTIONS

- Available as Lift & Slide
- Slimmer sightline of 45mm available
- Multiple sliding configurations
- Mono, Dual or Tri rail options
- Available in single and dual colour  
Anodised finishes also available
- Range of hardware and security features

## SPECIFICATIONS

Performance and accreditation	BSC94
U-value (double glazing)* (Ug = 1.0 W/m²K) (mono rail)	1.7 W/m²K
U-value (triple glazing)* (Ug = 0.7 W/m²K) (mono rail)	1.5 W/m²K
U-value (double glazing)* (Ug = 1.0 W/m²K) (dual Rail)	1.9 W/m²K
U-value (triple glazing)* (Ug = 0.7 W/m²K) (dual Rail)	1.7 W/m²K
Green guide rating	C rated
Acoustic performance (dB)	Rw (C;Ctr) 36 (-1;-3) dB**
Air tightness (Pa)***	Class 4 (600 Pa)
Water tightness (Pa)***	Class 7a (300 Pa)
Wind load (Pa)***	C3 (1200 Pa)
Security - PAS 24	✓
Configuration & frame	
Opening	Inline sliding
Mono rail (105mm)	✓
Dual rail (94mm)	✓
Tri rail (155mm)	✓
Size limits	
Max vent weight****	400kg
Max frame height†	3000mm
Max frame height with security features	2600mm
System features	
Dual colour option	✓
Multi-point locking	✓
Glazing options	Internal
Glazing thickness	20mm - 31mm
Sightlines	85mm

## BSC94 (IN-LINE) CONFIGURATIONS

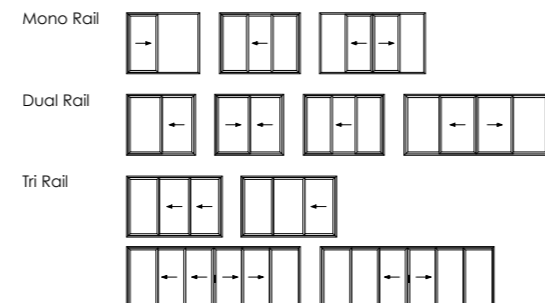
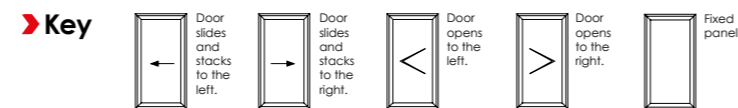

## CAD CROSS SECTIONS

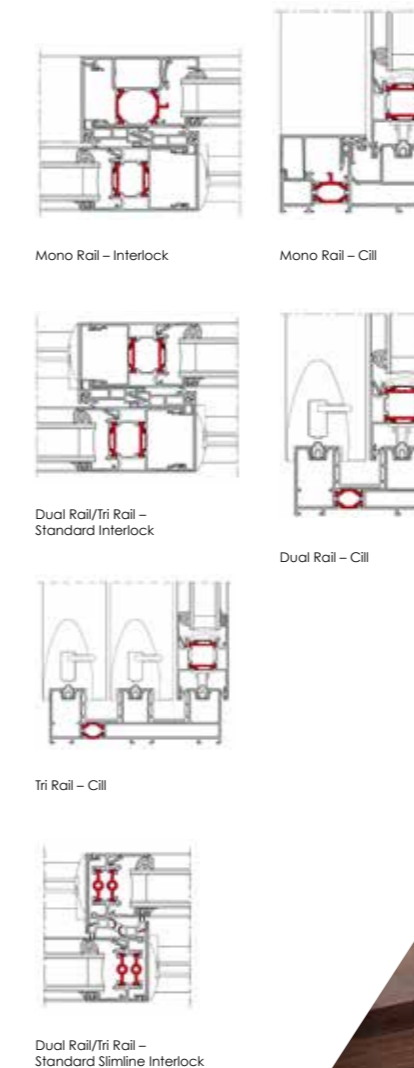

\*U-values based on CEN size door (2000mm x 2180mm).  
 \*\*Sound insulation values are Rw reduction values and are based on tests using acoustic glazing.  
 \*\*\*All weather test data taken from BS EN 6375-1 based upon highest performing door configuration.  
 \*\*\*\*Based on using double rollers.  
 †Dependent on wind load and lock variation.  
 Note: npd = No performance declared  
 Please visit [www.aluk.co.uk](http://www.aluk.co.uk) to download all BIM components and CAD files.

Luminia

# F82 Bi-fold Door

A contemporary, stylish bi-folding door, with thinner sightlines and an interlock of 122mm that provide larger glazing panels without compromising on performance.

It also offers HD compact slim stainless steel rollers as standard allowing for a smoother movement when opening and closing. And with the re-design of the flush pop-out handle, form and function work in perfect harmony.

Visit [f82.aluk.com](http://f82.aluk.com) for more information and to request a brochure.



## DESIGN FEATURES

- Re-designed flush pop-out handle
- Unique traffic door
- HD compact rollers as standard
- 4 stainless slim steel rollers
- Both frame and cill sightlines of 97mm
- All configurations available open in and open out

## OPTIONS

- Chamfered and square bead options
- Glazing 28mm - 54mm
- Available in a range of opening configurations
- Available in a range of single or dual colour and anodised finishes
- All configurations available open in and open out
- Chamfered and square based options

## SPECIFICATIONS

### Performance and accreditation

	F82
U value (double glazing) (Ug = 1.0 W/m²K)	1.4 W/m²K
U value (triple glazing) (Ug = 0.7 W/m²K)	1.2 W/m²K
Air tightness (Pa) (standard threshold)	Class 3 (600 Pa)
Water tightness (Pa) (standard threshold)	Class 5a (200 Pa)
Wind load (Pa)	Class 4A (1600 Pa)
Security - PAS 24	✓
3rd party certification	Npd
Secured by design	Npd

### Configurations

Opening	Open in and open out
2-2-0	✓
3-3-0	✓
3-2-1	✓
4-4-0	✓
4-2-2	✓
4-3-1	✓
5-5-0	✓
5-3-2	✓
5-4-1	✓
6-6-0	✓
6-3-3	✓
6-4-2	✓
6-5-1	✓
7-7-0	✓
7-4-3	✓
7-5-2	✓
7-6-1	✓

### Design features

Max vent weight	150Kg
Sightline (Head)	97mm
Sightline (Cill)	97mm
Sightline (Jamb)	97mm
Sightline (Meeting Stile)	122mm
Maximum leaf width	1200mm

### System features

Frame depth	82mm
Dual colour option	✓
Multi-point locking	✓
Glazing options	Internal bead
Glazing thickness	28mm - 54mm

### F82 HI

U value (double glazing) (Ug = 1.0 W/m²K)	1.3 W/m²K
U value (triple glazing) (Ug = 0.7 W/m²K)	1.1 W/m²K
Air tightness (Pa) (standard threshold)	Class 3 (600 Pa)
Water tightness (Pa) (standard threshold)	Class 5a (200 Pa)
Wind load (Pa)	Class 4A (1600 Pa)
Security - PAS 24	✓
3rd party certification	Npd
Secured by design	Npd

### Configurations

Opening	Open in and open out
2-2-0	✓
3-3-0	✓
3-2-1	✓
4-4-0	✓
4-2-2	✓
4-3-1	✓
5-5-0	✓
5-3-2	✓
5-4-1	✓
6-6-0	✓
6-3-3	✓
6-4-2	✓
6-5-1	✓
7-7-0	✓
7-4-3	✓
7-5-2	✓
7-6-1	✓

### Design features

Max vent weight	150Kg
Sightline (Head)	97mm
Sightline (Cill)	97mm
Sightline (Jamb)	97mm
Sightline (Meeting Stile)	122mm
Maximum leaf width	1200mm

### System features

Frame depth	82mm
Dual colour option	✓
Multi-point locking	✓
Glazing options	Internal bead
Glazing thickness	28mm - 54mm

## CAD CROSS SECTIONS

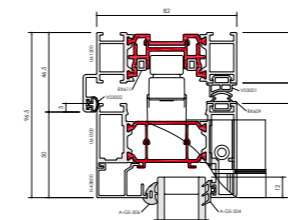

F82 Head

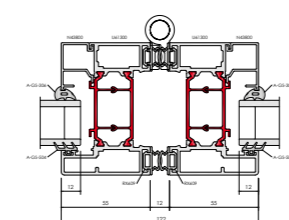

F82 Interlock

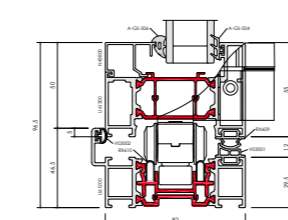

F82 Cill

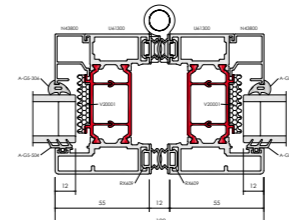

F82 HI Interlock

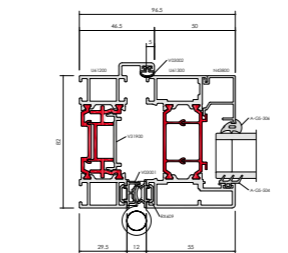

F82 Jamb

## F82 CONFIGURATIONS

### Key

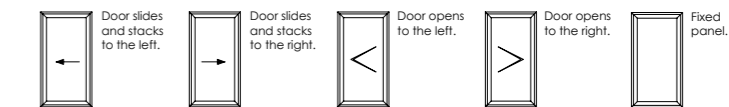

### Two Pane



### Four Pane

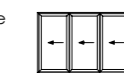

### Five Pane



### Six Pane

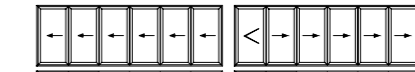

### Seven Pane

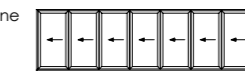

\* Folding Doors are calculated using EN ISO 10077 - Part 2, 3000mm x 2180mm, 3-3-0 Door with Ug: 1.0 W/m²K (double glazed) / 0.7 W/m²K (triple glazed) using P-06-100 outerframe and P-06-200 vent. Single and Double Door value is calculated using EN ISO 10077 - Part 2, 2000mm x 2180mm Double Door with Ug: 1.0 W/m²K (double glazed) / 0.7 W/m²K (triple glazed) using P-06-100 outerframe and P-06-200 vent.

• U-value (Double Glazing) - Folding Doors are calculated using EN ISO 10077 - Part 2, 3000mm x 2180mm, 3-3-0 Door with Ug: 1.0 W/m²K using P-06-100 outerframe and P-06-200 vent. Single and Double Door value is calculated using EN ISO 10077 - Part 2, 2000mm x 2180mm Double Door with Ug: 1.0 W/m²K using P-06-100 outerframe and P-06-200 vent.

† U-value (Triple Glazing) - Folding Doors are calculated using EN ISO 10077 - Part 2, 3000mm x 2180mm, 3-3-0 Door with Ug: 0.7 W/m²K using P-06-100 outerframe and P-06-200 vent. Single and Double Door value is calculated using EN ISO 10077 - Part 2, 2000mm x 2180mm Double Door with Ug: 0.7 W/m²K using P-06-100 outerframe and P-06-200 vent.

Optio

# BSF70 Bi-fold Door

An intelligent combination of form and function, our highly versatile and market-leading bi-fold sliding door system gives you maximum control over the style and operation of the doors.

Multiple panels can be added to accommodate the design specifications of your building, with the option to open in or out as required.

The system also boasts a unique flush line pop-out handle that allows for square flush stacking panels when doors are fully open.



#### DESIGN FEATURES

- Certified under the Secured By Design scheme
- Tested to PAS 24
- Unique, pop-out handle that allows for maximum door opening and panels to stack square
- Four stainless steel rollers to ensure smooth and consistent operation

#### OPTIONS

- Chamfered and square bead options
- Glazing 24mm - 40mm
- Available in a range of opening configurations
- Available with heavy duty rollers; BSF70 HD
- Available in a range of single or dual colour and anodised finishes
- Low threshold 15mm step height
- All configurations available open in and open out
- Chamfered and square based options
- Shootbolts top and bottom of the interlock for enhanced security
- Dedicated bottom bogey guide for consistent operation and enhanced security
- Double track threshold allowing greater stability

#### SPECIFICATIONS

Performance and accreditation	BSF70
U value (double glazing) (Ug = 1.0 W/m²K)	1.6 W/m²K
U value (triple glazing) (Ug = 0.7 W/m²K)	1.4 W/m²K
Air tightness (Pa) (standard threshold)	Class 4 (600 Pa)
Water tightness (Pa) (standard threshold)	Class 9a (600 Pa)
Wind load (Pa)	Class AE2400 (2400 Pa)
Security - PAS 24	✓
3rd party certification	Q-mark
Secured by design	✓

Configurations	Open in and open out
Opening	Open in and open out
2-2-0	✓
3-3-0	✓
3-2-1	✓
4-4-0	✓
4-2-2	✓
4-3-1	✓
5-5-0	✓
5-3-2	✓
5-4-1	✓
6-6-0	✓
6-3-3	✓
6-4-2	✓
6-5-1	✓
7-7-0	✓
7-4-3	✓
7-5-2	✓
7-6-1	✓

Design features	
Max vent weight	100Kg
Sightline (Head)	110mm
Sightline (Cill)	130mm
Sightline (Jamb)	110mm
Sightline (Meeting Stile)	140mm

#### System features

Frame depth	70mm
Dual colour option	✓
Multi-point locking	✓
Glazing options	Internal bead
Glazing thickness	24mm - 40mm

#### BSF70 HD

1.6 W/m²K
1.4 W/m²K
Npd
Npd
Npd
Npd
Npd
Npd

#### Open in and open out

✓
✓
✓
✓
✓
✓
✓
✓
✓
✓
✓
✓
✓
✓
✓

130Kg
110mm
130mm
110mm
140mm
70mm
✓
✓
Internal bead
24mm - 40mm

#### CAD CROSS SECTIONS

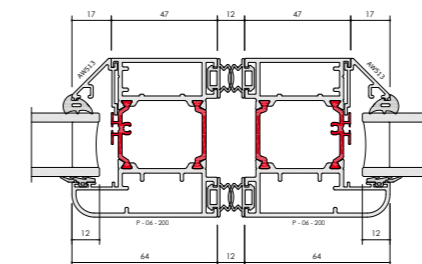
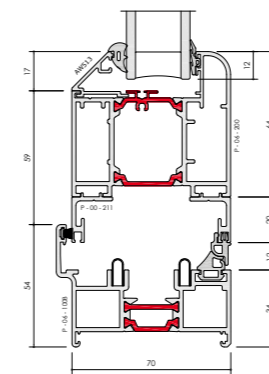

\* Folding Doors are calculated using EN ISO 10077 - Part 2, 3000mm x 2180mm, 3-3-0 Door with Ug: 1.0 W/m²K (double glazed) / 0.7 W/m²K (triple glazed) using P-06-100 outerframe and P-06-200 vent. Single and Double Door value is calculated using EN ISO 10077 - Part 2, 2000mm x 2180mm Double Door with Ug: 1.0 W/m²K (double glazed) / 0.7 W/m²K (triple glazed) using P-06-100 outerframe and P-06-200 vent.

• U-value (Double Glazing) - Folding Doors are calculated using EN ISO 10077 - Part 2, 3000mm x 2180mm, 3-3-0 Door with Ug: 1.0 W/m²K using P-06-100 outerframe and P-06-200 vent. Single and Double Door value is calculated using EN ISO 10077 - Part 2, 2000mm x 2180mm Double Door with Ug: 1.0 W/m²K using P-06-100 outerframe and P-06-200 vent.

• U-value (Triple Glazing) - Folding Doors are calculated using EN ISO 10077 - Part 2, 3000mm x 2180mm, 3-3-0 Door with Ug: 0.7 W/m²K using P-06-100 outerframe and P-06-200 vent. Single and Double Door value is calculated using EN ISO 10077 - Part 2, 2000mm x 2180mm Double Door with Ug: 0.7 W/m²K using P-06-100 outerframe and P-06-200 vent.

#### BSF70 CONFIGURATIONS

#### Key

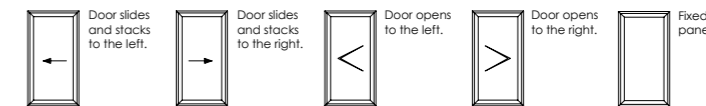

# Finish in style

**When it comes to designing aluminium façade systems, we go to great lengths to ensure every part plays its part to perfection. No shortcuts are taken, no corners cut.**

We take the exact same approach when it comes to developing hardware. Every product is designed to not only complement our systems, but strikingly enhance them too.

Our tested, tried and trusted hardware range includes suited handles, locks, hinges, rollers, bogeys, seals and brushes. Each and every product has to pass our famously stringent tests, with most subjected to 50,000 operational cycles to emulate a lifetime of trouble-free operation. Then the real testing begins.

Our quality assurance team surveys every nut, every screw, every surface to ensure it's both scratch-free and up to scratch.

We also believe security should be a standard, not an aspiration. It's why almost every aluminium door system featuring our hardware is certified by the Secured by Design scheme.

Of course, added strength and security should never compromise style. And certainly never function. It's why our hardware products not only improve ease of operation for years to come, but deliver a timeless look and finish.



**T: 01291 639 739**  
**E: [info.uk@aluk.com](mailto:info.uk@aluk.com)**

Registered Office:  
AluK (GB) Ltd  
Newhouse Farm Ind Est  
Chepstow  
NP16 6UD

Registered Number:  
02881320

**[aluk.co.uk](http://aluk.co.uk)**

**Experts in Aluminium**

**ALUK<sup>®</sup>**